

5 VDC RELAY MODULE HW-307. ON / OFF FUNCTION, CONTROLLED BY TTP223-AB CAPACITIVE TOUCH SENSOR (TOGGLE MODE, POWER ON STATE = HIGH (1)).

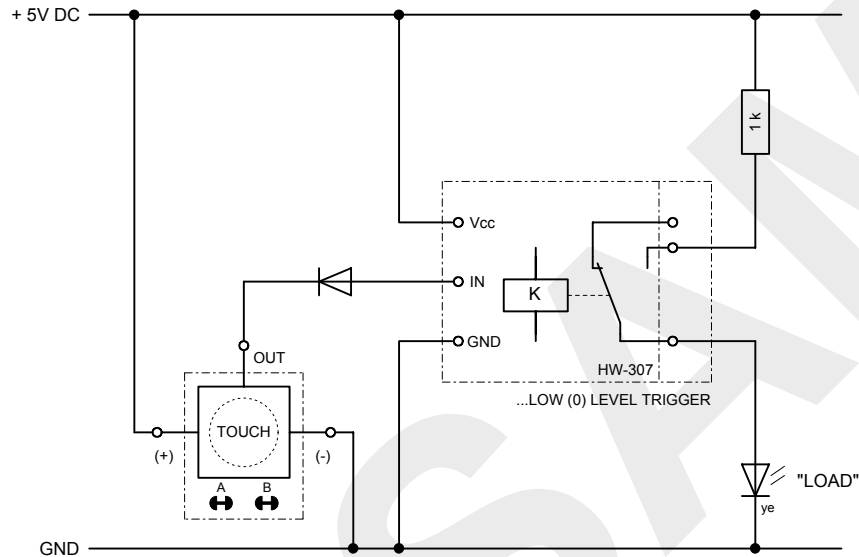

TRANSISTOR

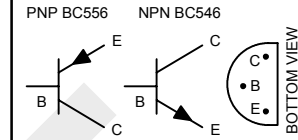

RESISTOR:

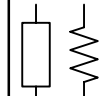

DIODE:

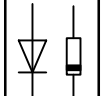

LED:

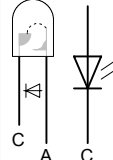

5V RELAY MODULE HW-307:

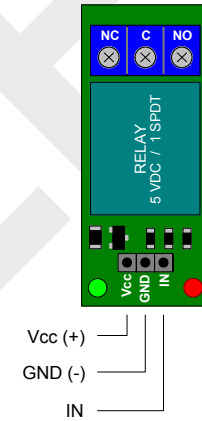

CAPACITOR:

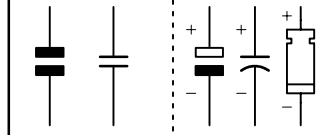

TTP223-AB CAPACITIVE TOUCH SENSOR:

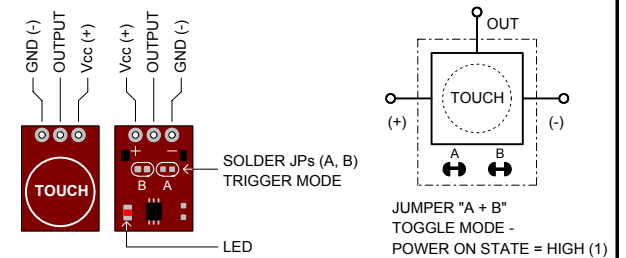

FOR FULLY COMPONENT SPECS. SEE MANUFACTURER DATASHEETS

RY-4	A4	udo@elgers.com	ue-ERT20220203-59	03-FEB-2022
023	A	HW-307 RELAY MODULE - EXPERIMENT 19		