

AMV-4E

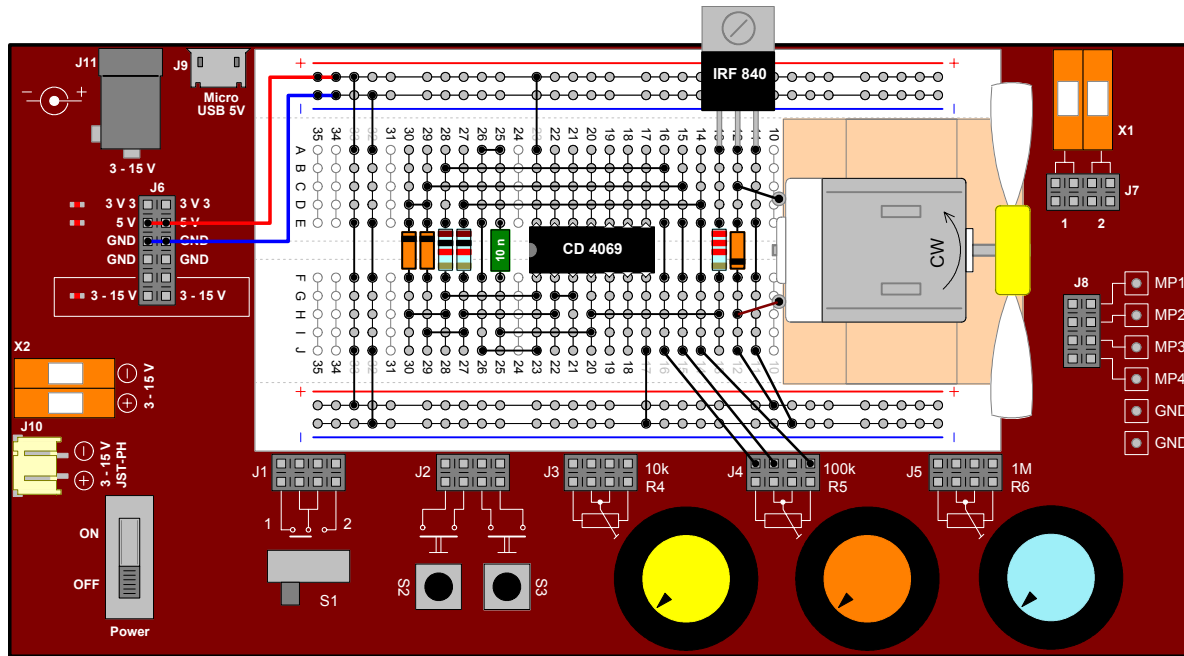

PROFESSIONAL EXPERIMENTS
WITH MINI BREADBOARD AND STANDARD COMPONENTS

ASTABLE MULTIVIBRATOR "AMV" WITH NOT-GATE IC - 05
CONFIGURED AS "PWM" DC-MOTOR SPEED CONTROLLER CIRCUIT
+ 5 V

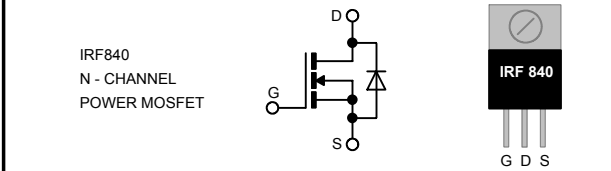
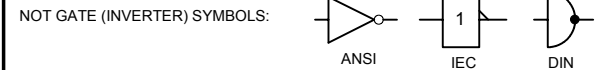
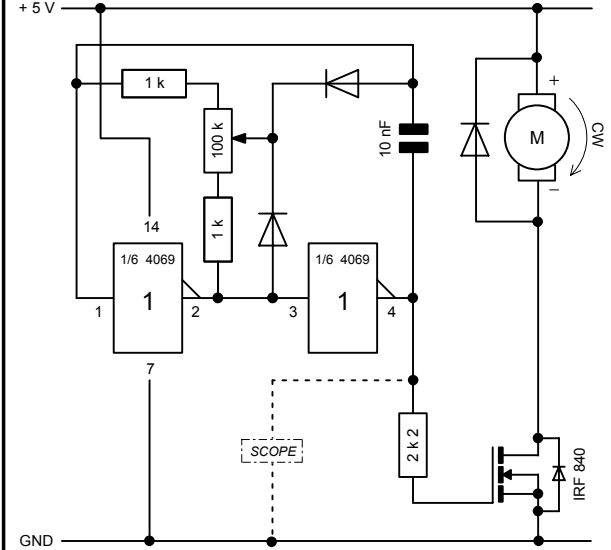

MIN. SPEED

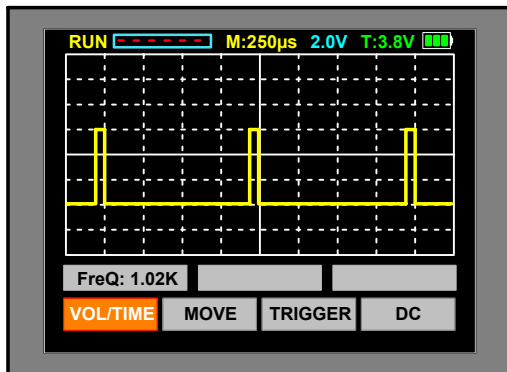

MAX. SPEED

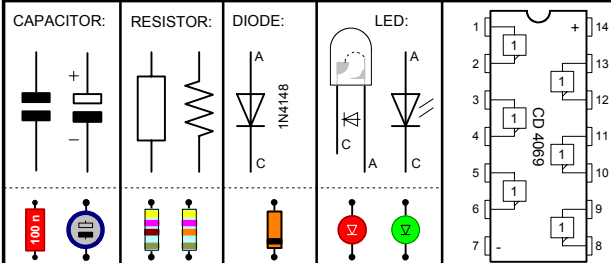
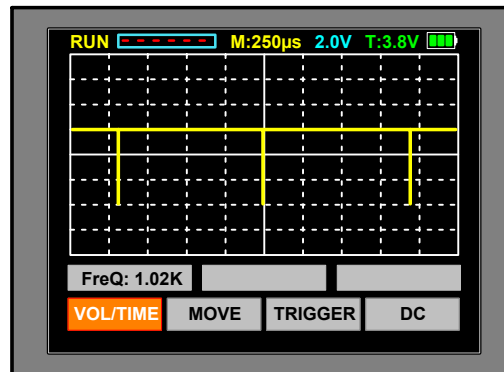

FIGURES ARE APPROXIMATELY, DUE TO COMPONENT TOLERANCES!
FOR FULLY COMPONENT SPECS. SEE MANUFACTURER DATASHEETS.
BRANDS AND NAMES ARE MENTIONED PURELY FOR INFORMATION PURPOSES.

EXSB-M01	A4	udo@elgers.com	ue-ERT20240602-05	02-JUN-2024
023	A	EXSB-mini BREADBOARD - AMV CIRCUIT		