

INFO

WWW.RETRO-CIRCUITS.COM

1 CHANNEL - RELAY MODULE KY-019

HIGH (1) LEVEL TRIGGERED 5 VDC RELAY MODULE WITH SPDT CONTACT.

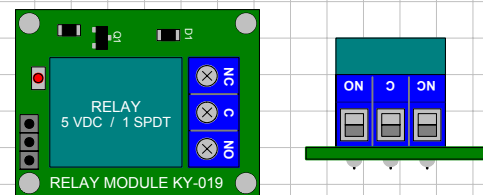

RYM INFO	A4	udo@elgers.com	ue-ERT20210301-01	01-MAR-2021
	A	5V RELAY MODULE KY-019 (H-TRIGGER)		

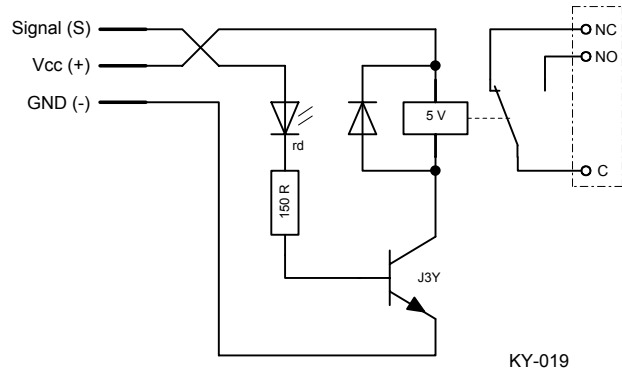

KY-019

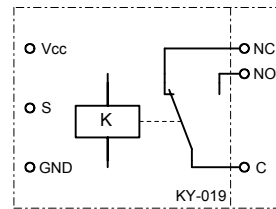

...HIGH LEVEL TRIGGER

TRANSISTOR:

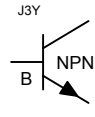

TOP VIEW

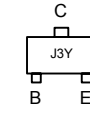

RESISTOR:

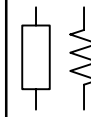

DIODE:

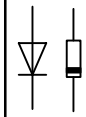

LED:

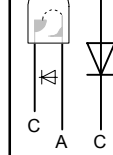

RELAY SRD-05VDC-SL-C:

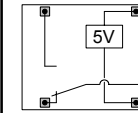

TOP VIEW

5 VDC / 10 A - 250 VAC

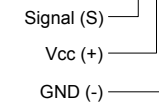
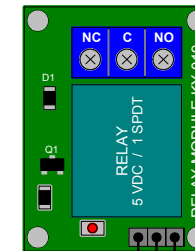
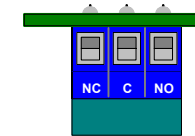

RYM INFO	A4	udo@elgers.com	ue-ERT20210301-02	01-MAR-2021
	A	5V RELAY MODULE KY-019 (H-TRIGGER)		

www.retro-circuits.com

The information in this brochure is for hobby and education / training purposes only and should not be regarded as a binding presentation of any specific product. No part of this brochure may be reproduced!

DISCLAIMER:

This brochure provides a selection of general everyday information. The information in this brochure is believed correct. However the author can not have full knowledge of your application. Therefore you are responsible for ensuring the safety and operability of your design. The author can not be held responsible for any damages resulting from the information in this brochure. If you do not agree with this disclaimer, pls. do not use the information out of this brochure.

WARNING:

IF YOU'RE NOT FAMILIAR WITH THE PRECAUTIONS THAT SHOULD BE TAKEN WHEN WORKING WITH VOLTAGES OVER 24 V, SEEK FOR ADDITIONAL GUIDANCE BEFORE CONNECTING ANY CIRCUIT TO HIGH VOLTAGE SOURCES SUCH AS HOUSEHOLD MAINS LINES OF 120 ... 240 VAC OR EVEN HIGHER. THESE VOLTAGE LEVELS ARE VERY DANGEROUS!

ACCORDING TO LOCAL AND INTERNATIONAL REGULATIONS, WORKING WITH MAINS VOLTAGE IS RESERVED FOR QUALIFIED ELECTRICIANS ONLY!!!

Bad Bentheim, 1st. March 2021

Udo Elger

Udo Elger
48455 Bad Bentheim / Kuhlenkamp 22
Germany
Email: info@retro-circuits.com