

FT 200 CLASSIC - VINTAGE - KIT

SUPPLEMENT PARTS LISTS AND CARDBOARD CUTTING TEMPLATES

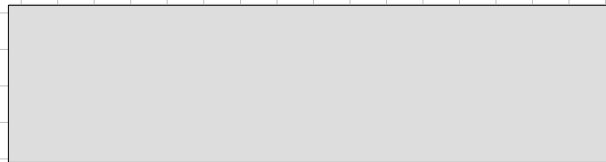
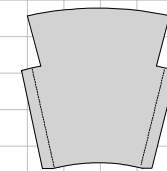
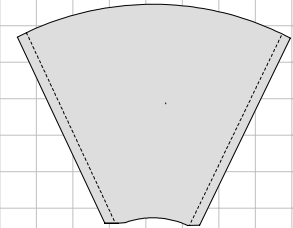
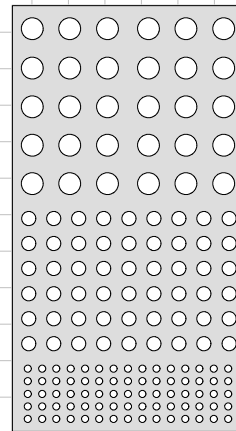
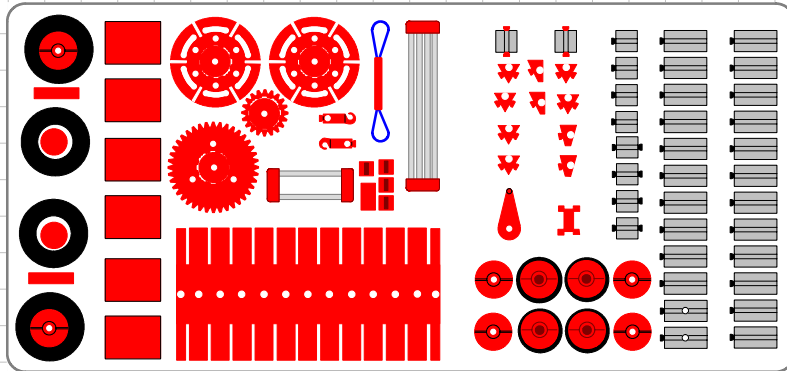

FT-CLASSIC	A4	udo@elgers.com	ue-ERT20250325-01	25-MAR-2025
001	A	FT CLASSIC - VINTAGE - KIT - SUPPLEMENT		

www.retro-circuits.com

FOR FULLY COMPONENT SPECS. SEE MANUFACTURER INFORMATION.

BRANDS AND NAMES ARE MENTIONED PURELY FOR INFORMATION PURPOSES AND DOES NOT CONSTITUTE TRADEMARK ABUSE!

THE USE OF THIS BROCHURE AND THE IMPLEMENTATION OF THE INFORMATION CONTAINED IN IT IS EXPRESSLY AT YOUR OWN RISK!

THE AUTHOR RESERVES THE RIGHT NOT TO BE RESPONSIBLE FOR THE TOPICALITY, CORRECTNESS, COMPLETENESS OR QUALITY OF THE INFORMATION PROVIDED IN THIS BROCHURE. LIABILITY CLAIMS REGARDING DAMAGE CAUSED BY THE USE OF ANY INFORMATION PROVIDED, INCLUDING ANY KIND OF INFORMATION WHICH IS INCOMPLETE OR INCORRECT, WILL THEREFORE BE REJECTED.

THE AUTHOR INTENDED NOT TO USE ANY COPYRIGHTED MATERIAL FOR THIS BROCHURE. THE COPYRIGHT FOR ANY MATERIAL CREATED BY THE AUTHOR IS RESERVED. ANY DUPLICATION OR USE OF OBJECTS SUCH AS DIAGRAMMS, SOUNDS OR TEXTS IN OTHER ELECTRONIC OR PRINTED PUBLICATIONS IS NOT PERMITTED WITHOUT THE AUTHOR'S AGREEMENT.

Bad Bentheim, 24th. Mar. 2025

Udo Elger

NOTE: ...all included QR codes are links to the original OEM assembly instructions on: www.fischertechnikclub.nl

Udo Elger
48455 Bad Bentheim / Kuhlenkamp 22
Germany
Email: info@retro-circuits.com

CRAFT CARDBOARD PARTS 0.35 mm THICK

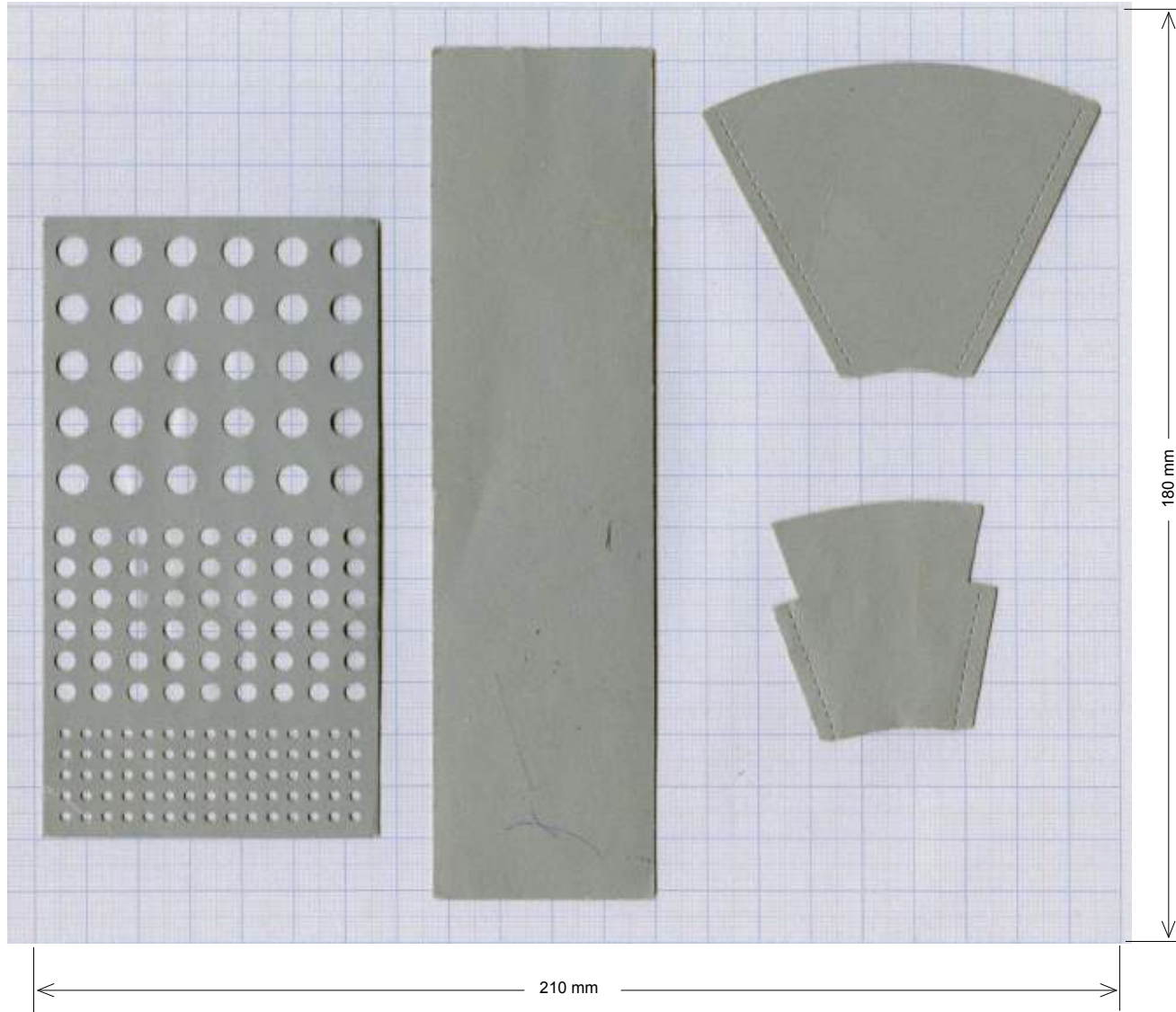

FT BASIC CONSTRUCTION KIT 200 - 1969 - 30200

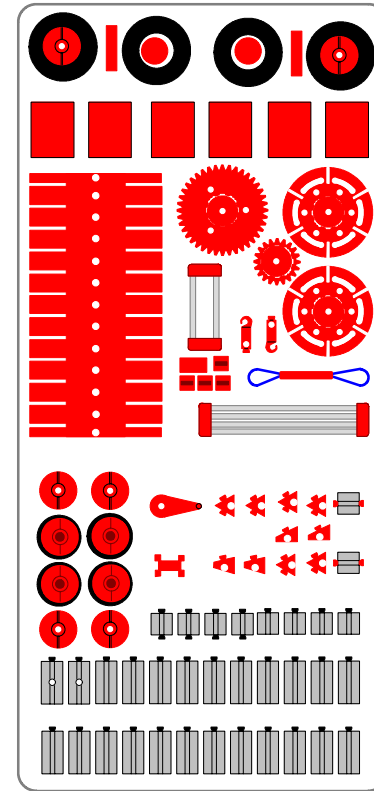

FT MOTOR SUPPLEMENT KIT mot. 1 - 30091

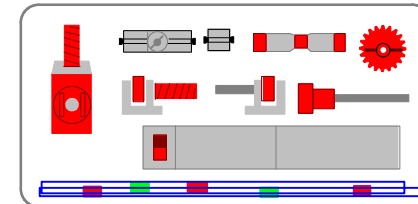

FIGURES ARE APROXMEIATELY, DUE TO COMPONENT TOLERANCES!
 FOR FULLY COMPONENT SPECS. SEE MANUFACTURER DATASHEETS.
 BRANDS AND NAMES ARE MENTIONED PURELY FOR INFORMATION PURPOSES.

FT-CLASSIC	A4	udo@elgers.com	ue-ERT20250324-03	24-MAR-2025
003	A	FT CLASSIC - VINTAGE - KIT - SUPPLEMENT		

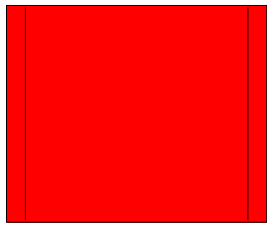

6x 31013

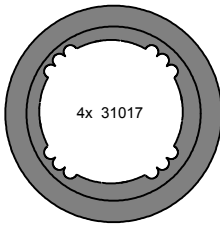

4x 31017

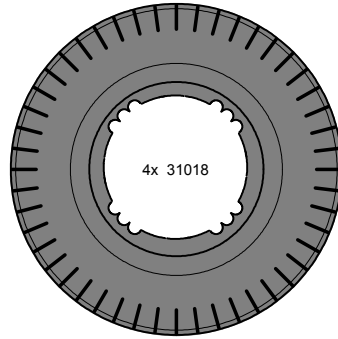

4x 31018

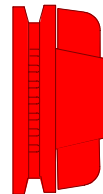

2x 31015

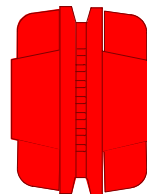

8x 31014

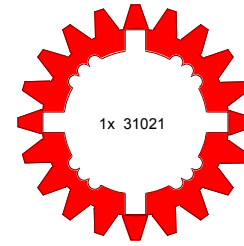

1x 31021

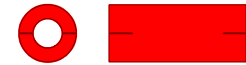

1x 31024

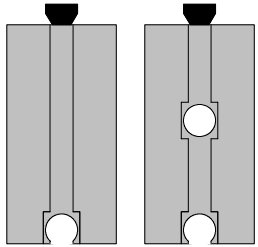

22x 31003

2x 31004



2x 31061

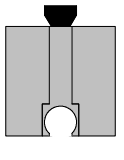

4x 31005

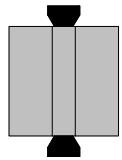

4x 31006

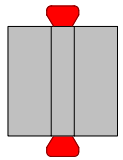

2x 31007



6x 31010



2x 31011



2x 31012



2x 31025



6x 31023

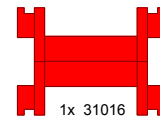

1x 31016

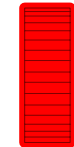

2x 31020

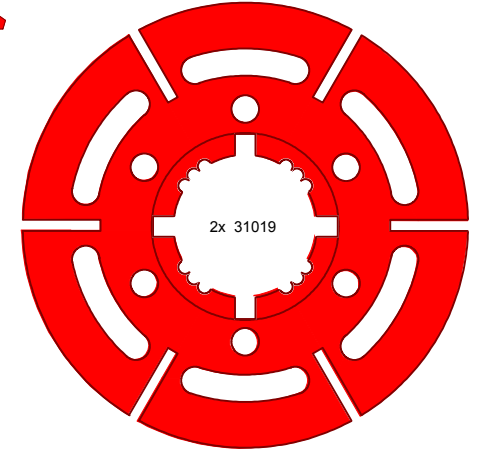

2x 31019

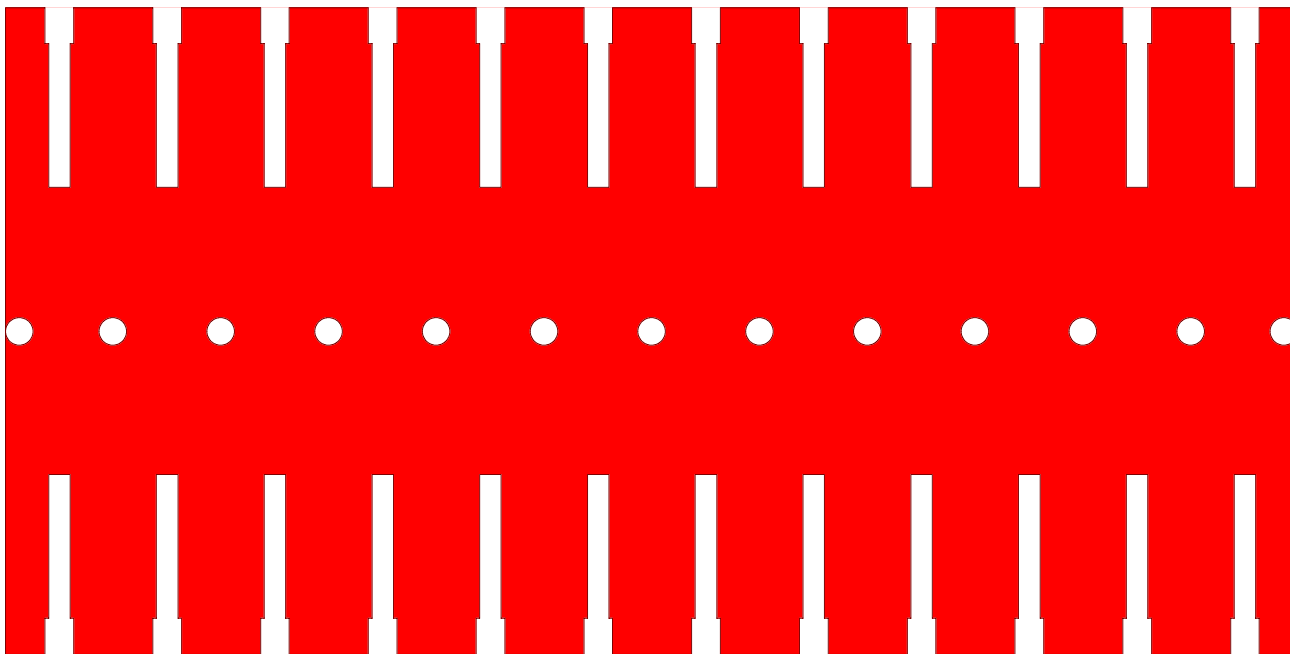

1x 31001

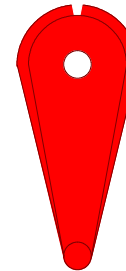

1x 31026

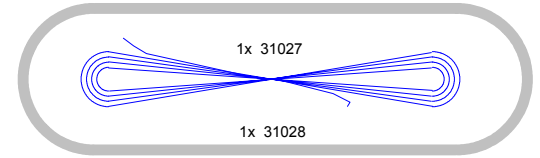

1x 31027

1x 31028

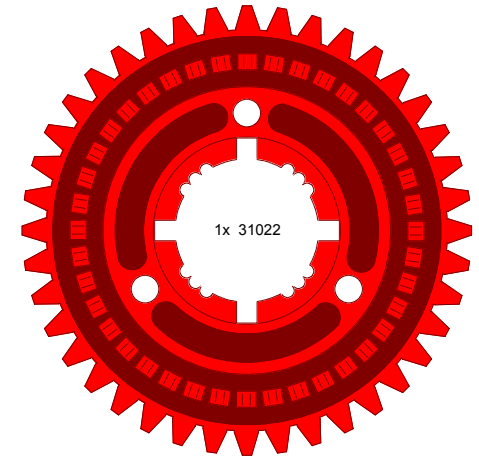

1x 31022



2x 31031



2x 31032



4x 31033



4x 31030

FIGURES ARE APROXMIATELY, DUE TO COMPONENT TOLERANCES!
FOR FULLY COMPONENT SPECS. SEE MANUFACTURER DATASHEETS.
BRANDS AND NAMES ARE MENTIONED PURELY FOR INFORMATION PURPOSES.

FT-CLASSIC	A4	udo@elgers.com	ue-ERT20250325-02	25-MAR-2025
004	A	FT CLASSIC - VINTAGE - KIT - SUPPLEMENT		

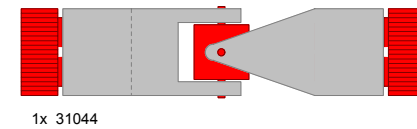
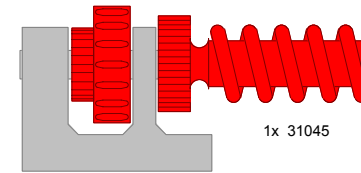
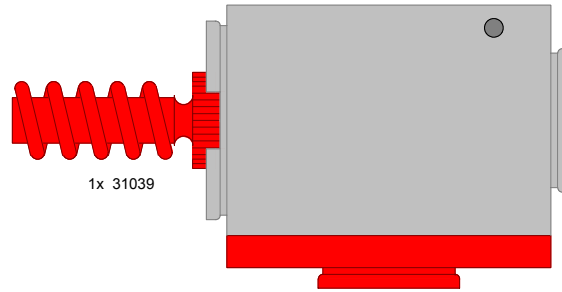
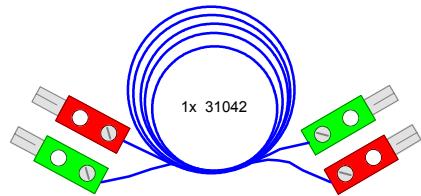
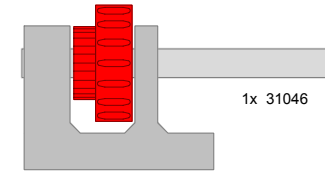
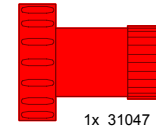
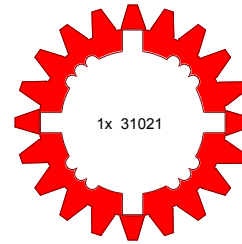
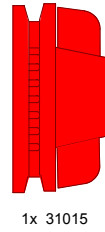
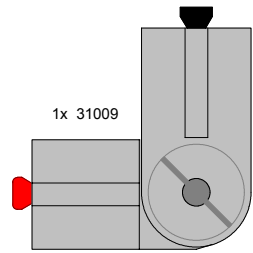
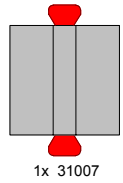

FIGURES ARE APROXMIATELY, DUE TO COMPONENT TOLERANCES!
 FOR FULLY COMPONENT SPECS. SEE MANUFACTURER DATASHEETS.
 BRANDS AND NAMES ARE MENTIONED PURELY FOR INFORMATION PURPOSES.

FT-CLASSIC	A4	udo@elgers.com	ue-ERT20250325-03	25-MAR-2025
005	A	FT CLASSIC - VINTAGE - KIT - SUPPLEMENT		

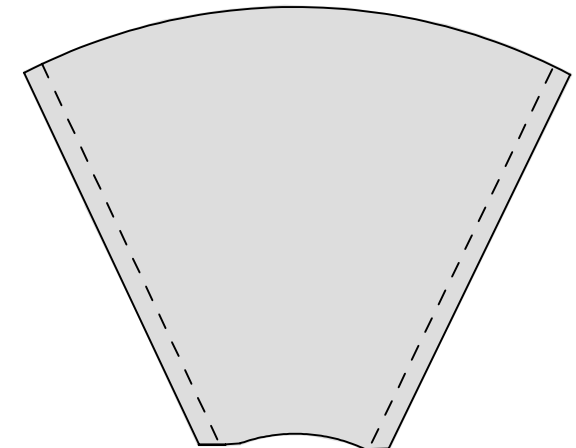
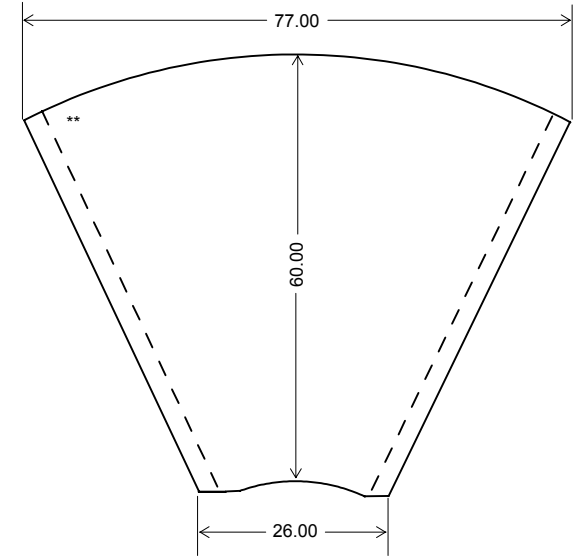
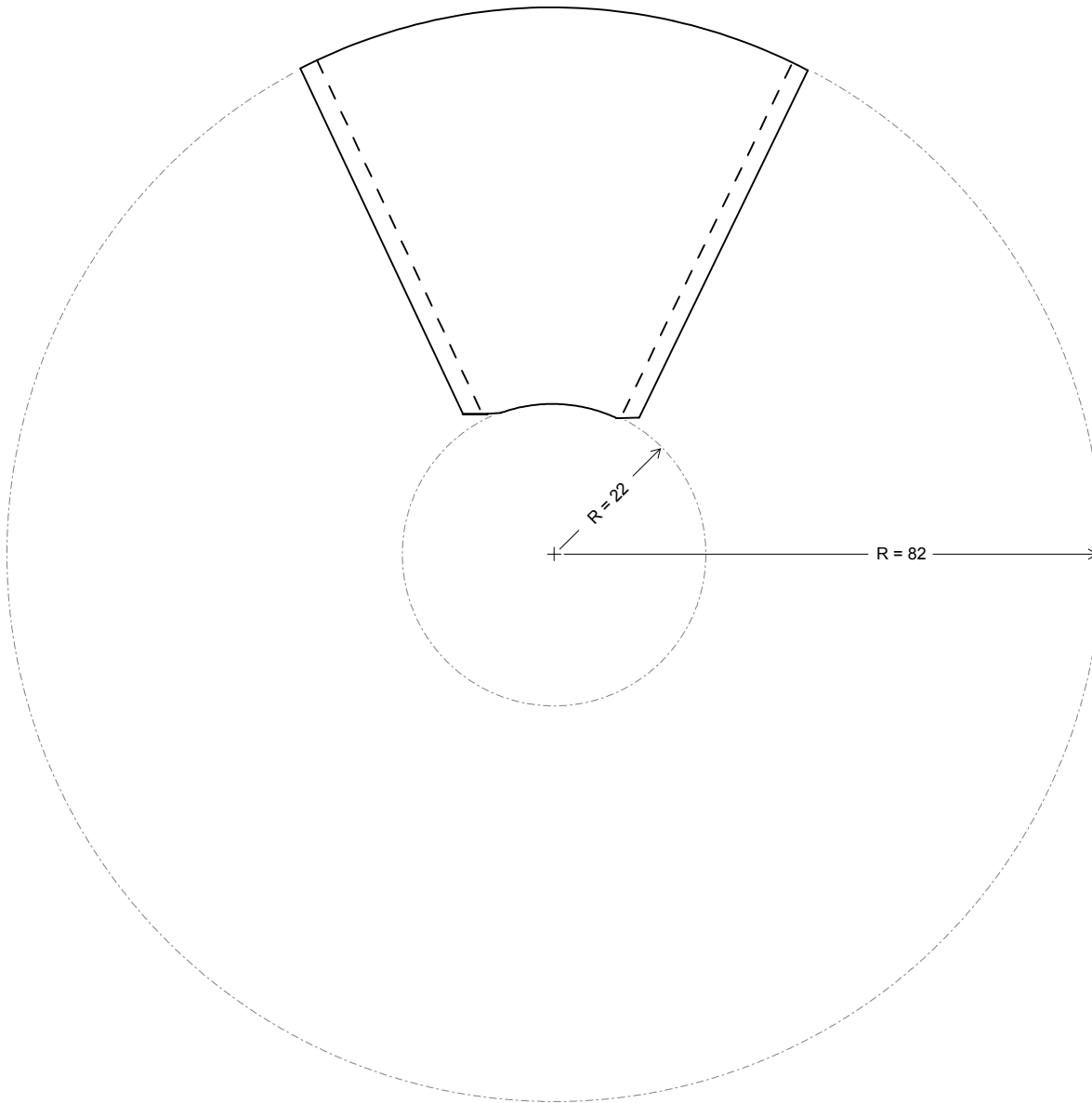

** 0.35 mm CRAFT CARDBOARD

FIGURES ARE APPROXIMATELY, DUE TO COMPONENT TOLERANCES!
 FOR FULLY COMPONENT SPECS. SEE MANUFACTURER DATASHEETS.
 BRANDS AND NAMES ARE MENTIONED PURELY FOR INFORMATION PURPOSES.

FT-CLASSIC	A4	udo@elgers.com	ue-ERT20250324-01	24-MAR-2025
006	A	FT CLASSIC - VINTAGE - KIT - SUPPLEMENT		

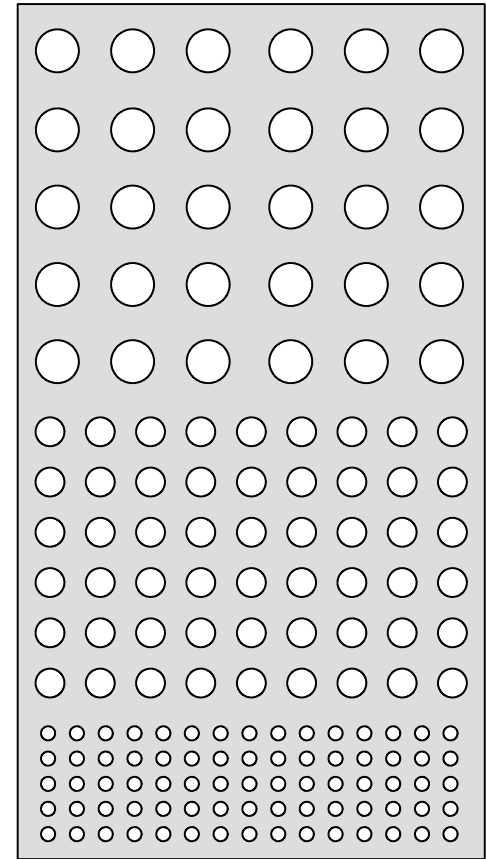
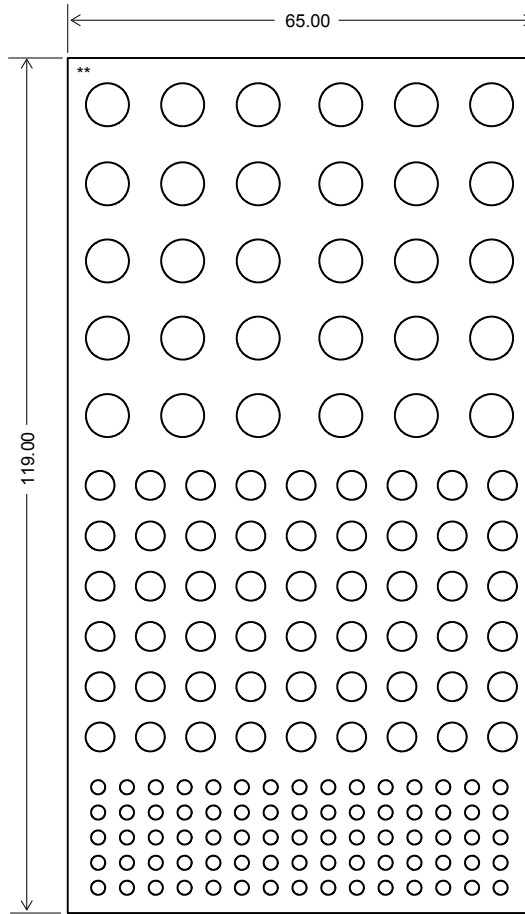
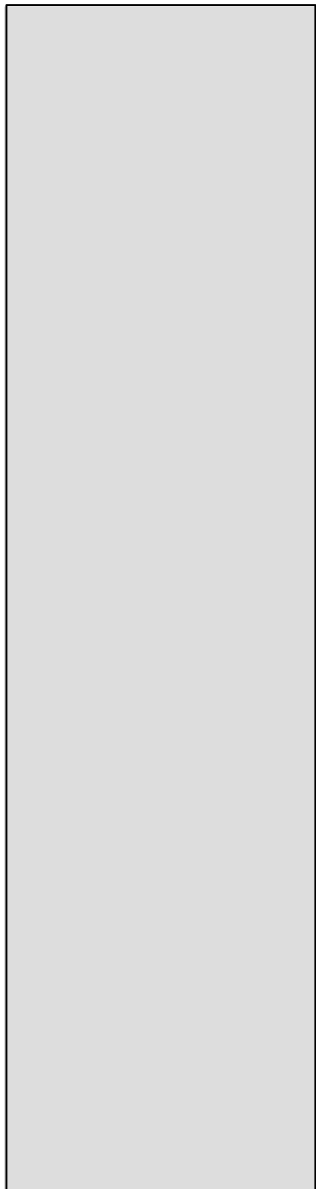
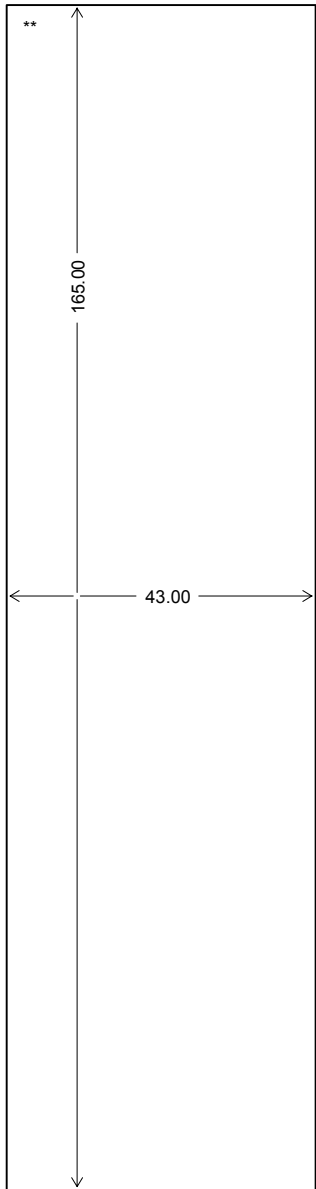

SIEB 65 x 119 mm:
 30 x 6 mm HOLES
 54 x 4 mm HOLES
 75 x 2 mm HOLES

** 0.35 mm CRAFT CARDBOARD

FIGURES ARE APROXIMATELY, DUE TO COMPONENT TOLERANCES!
 FOR FULLY COMPONENT SPECS. SEE MANUFACTURER DATASHEETS.
 BRANDS AND NAMES ARE MENTIONED PURELY FOR INFORMATION PURPOSES.

FT-CLASSIC	A4	udo@elgers.com	ue-ERT20250324-02	24-MAR-2025
007	A	FT CLASSIC - VINTAGE - KIT - SUPPLEMENT		

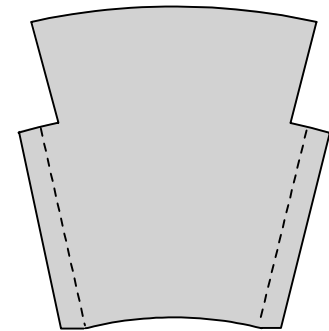
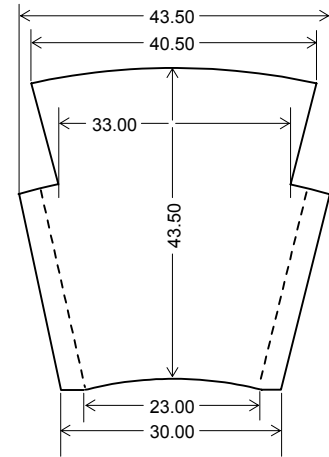
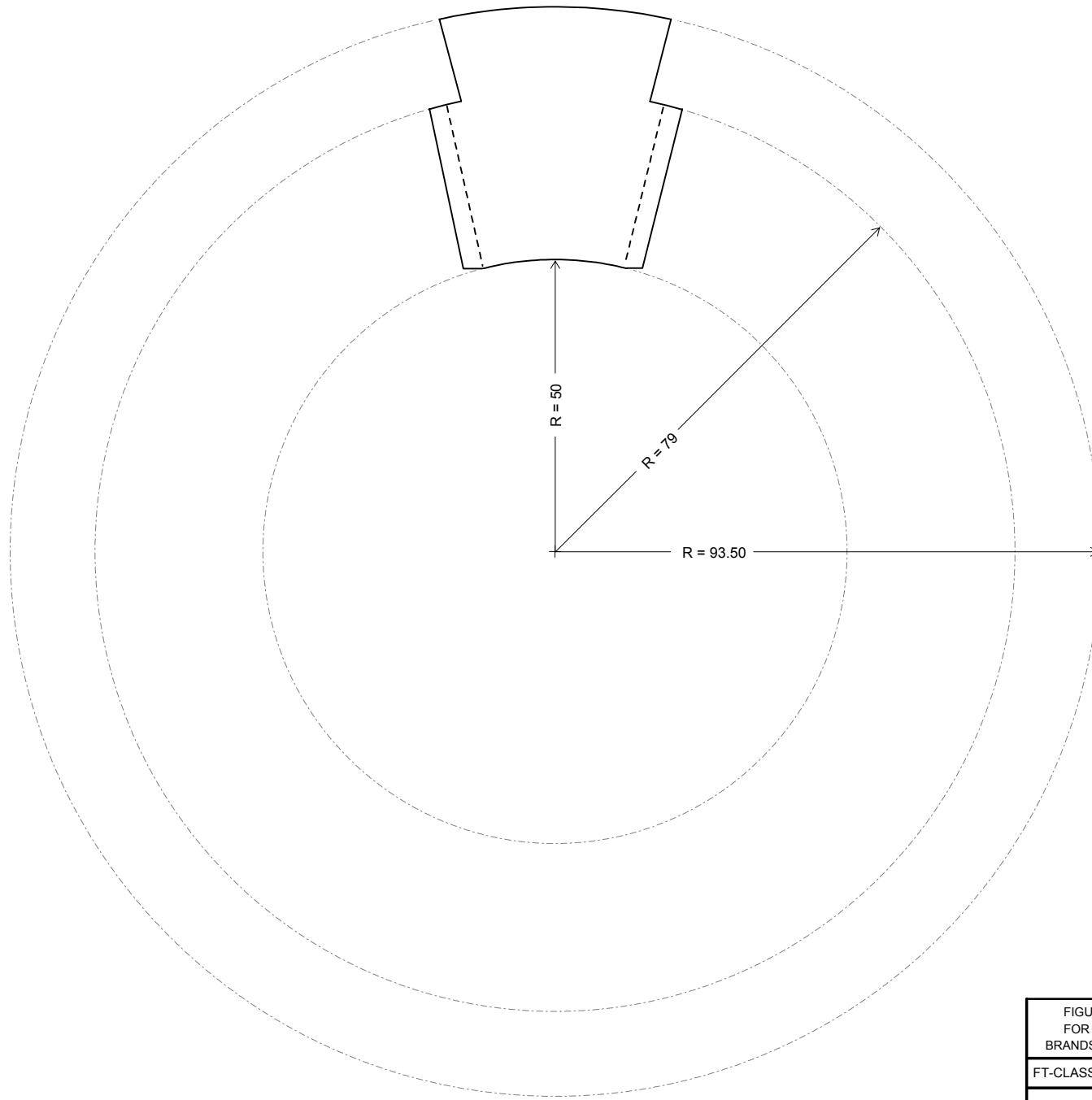

** 0.35 mm CRAFT CARDBOARD

FIGURES ARE APROXIMATELY, DUE TO COMPONENT TOLERANCES!
 FOR FULLY COMPONENT SPECS. SEE MANUFACTURER DATASHEETS.
 BRANDS AND NAMES ARE MENTIONED PURELY FOR INFORMATION PURPOSES.

FT-CLASSIC	A4	udo@elgers.com	ue-ERT20250324-03	24-MAR-2025
008	A	FT CLASSIC - VINTAGE - KIT - SUPPLEMENT		

FT BASIC CONSTRUCTION KIT 200 - P/N: 30299 - 1969

- 31001 BASE PLATE 180 x 90
- 31003 BUILDING BLOCK 30, GREY
- 31004 BUILDING BLOCK 30 WITH BORE, GREY
- 31005 BUILDING BLOCK 15, grey
- 31006 BUILDING BLOCK 15 WITH 2 PIN, GREY
- 31007 BUILDING BLOCK 15 WITH 2 RED ROUND PIN, GREY
- 31010 ANGLE BLOCK 60°, RED
- 31011 ANGLE BLOCK 30°, RED
- 31012 ANGLE BLOCK 30° RETANGULAR, RED
- 31013 FLATBLOCK 30, RED
- 31014 HUB ASSY, RED
- 31015 FLAT HUB ASSY, RED
- 31016 WINCH DRUM, RED
- 31017 TIRE 30, BLACK
- 31018 TIRE 45, BLACK
- 31019 LARGE PULLEY 60, RED
- 31020 CLAMPING RING FOR WINCH DRUM, RED
- 31021 GEAR WHEEL T=20 M1.5, RED
- 31022 GEAR WHEEL T=40/32 M1.5, RED
- 31023 CLIP 10, RED
- 31024 COUPLING FOR MATAL AXLE
- 31025 HOOK
- 31026 HAND CRANK
- 31027 NYLON ROPE 2000, BLUE
- 31028 DRIVE SPRING 270
- 31030 HOLDER FOR METAL AXLE
- 31031 METAL AXLE 110, SILVER
- 31032 METAL AXLE 60, SILVER
- 31033 METAL AXLE 50, SILVER
- 31061 LINK 30, RED
- 35795 ROPE PULLEY

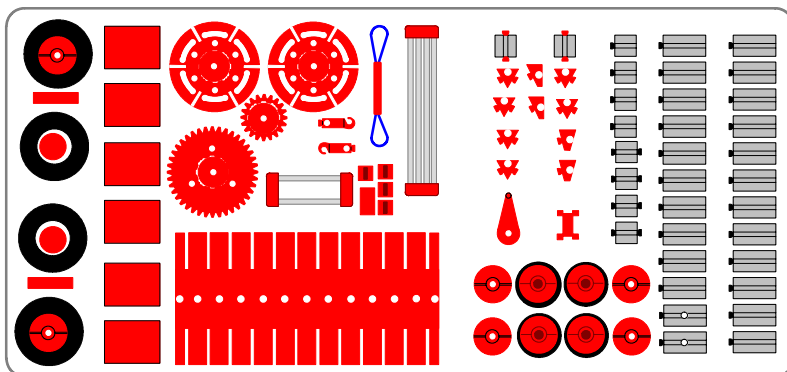
**FT MOTOR SUPPLEMENT KIT mot.1 - P/N: 30091 - 1969**

- 31007 BUILDING BLOCK 15 WITH 2 RED ROUND PIN, GREY
- 31009 ELBOW JOINT, 1 BLACK & 1 RED PIN
- 31015 FLAT HUB ASSY, RED
- 31021 GEAR WHEEL T=20 M1.5, RED
- 31032 METAL AXLE 60, SILVER
- 31039 6V M-MOTOR
- 31041 4.5V BATTERY STICK
- 31042 CABLE 1000 ASSY WITH 2 RED & 2 GREEN PLUGS, BLUE
- 31044 UNIVERSAL JOINT
- 31045 10:1 GEAR ADAPTER WITH WORM DRIVE
- 31046 10:1 GEAR ADAPTER WITH METAL AXLE DRIVE
- 31047 PINION T=10 M1.5 WITH COLLET, RED

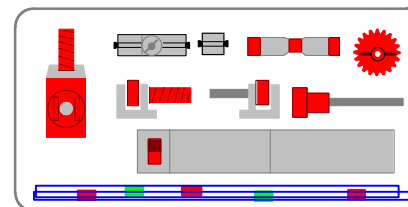

FT-CLASSIC	A4	udo@elgers.com	ue-ERT20250325-04	25-MAR-2025
009	A	FT CLASSIC - VINTAGE - KIT - SUPPLEMENT		

NOTES:

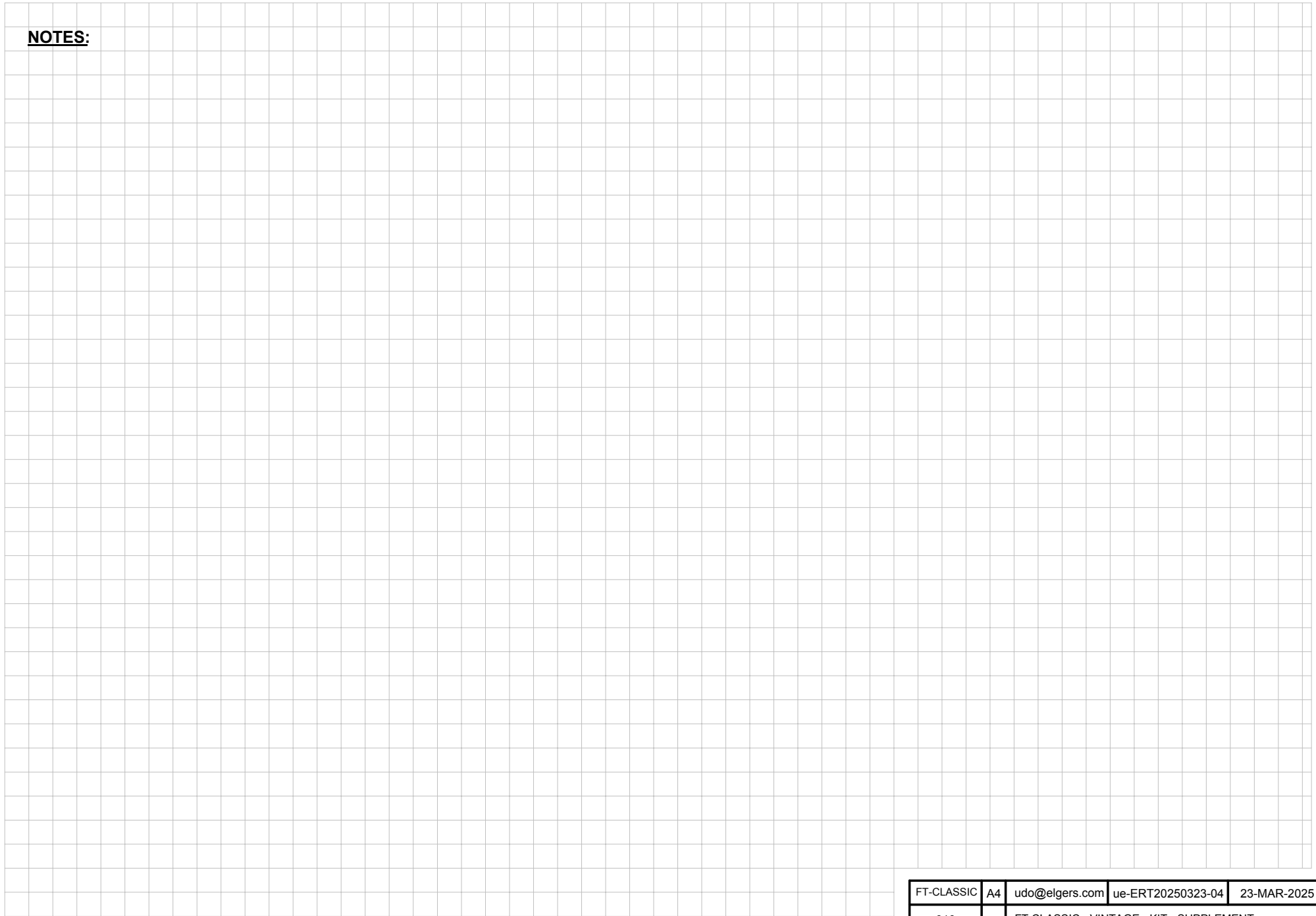

FT-CLASSIC	A4	udo@elgers.com	ue-ERT20250323-04	23-MAR-2025
010	A	FT CLASSIC - VINTAGE - KIT - SUPPLEMENT		